

# EDE Series

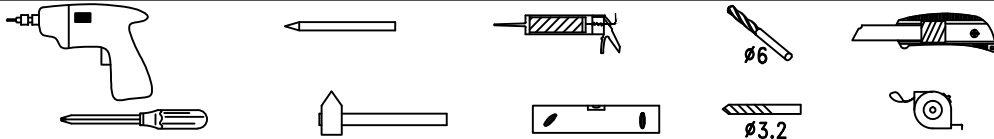

<p>N09</p> <p>30 ST4</p> <p>8X</p>	<p>N10</p> <p>8X</p>	<p>N11</p> <p>10 ST4</p> <p>6X</p>	<p>N12</p> <p>6X</p>	<p>N13</p> <p>22 M8</p> <p>6X</p>	<p>N14</p> <p>1X</p>
<p>N15</p> <p>2X</p>	<p>N16</p> <p>8X</p>	<p>N17</p> <p>M6</p> <p>2X</p>	<p>N18</p> <p>M8</p> <p>8X</p>	<p>N19</p> <p>6 <math>\phi 10</math></p> <p>4X</p>	<p>N20</p> <p>2X</p>

1

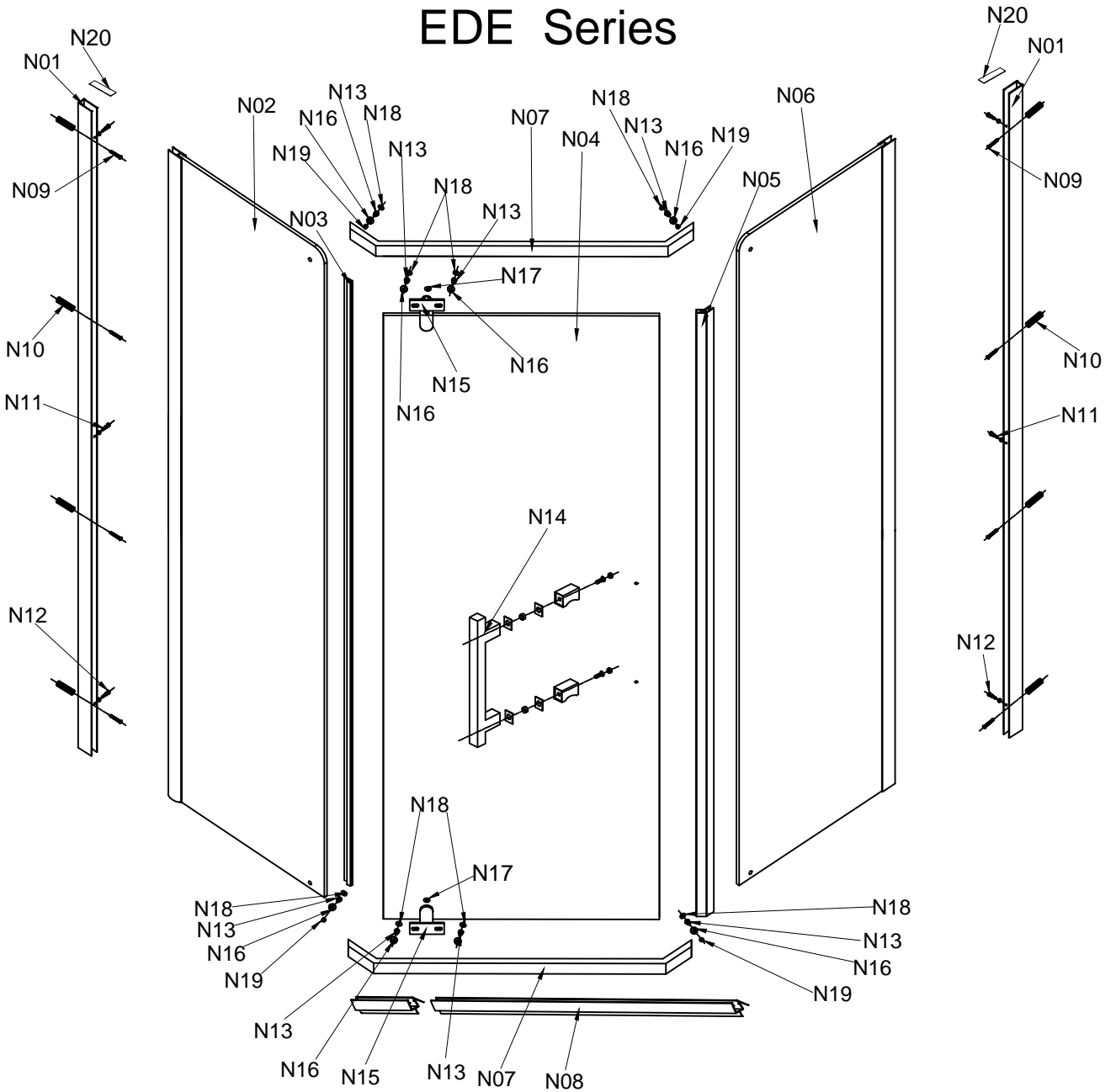
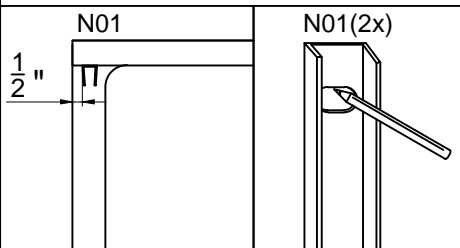
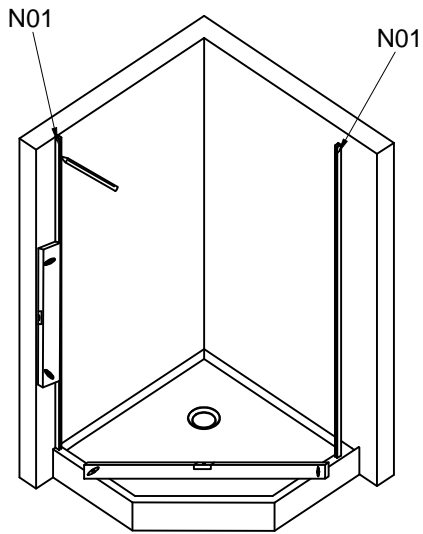

2

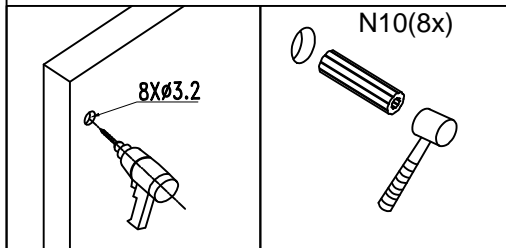
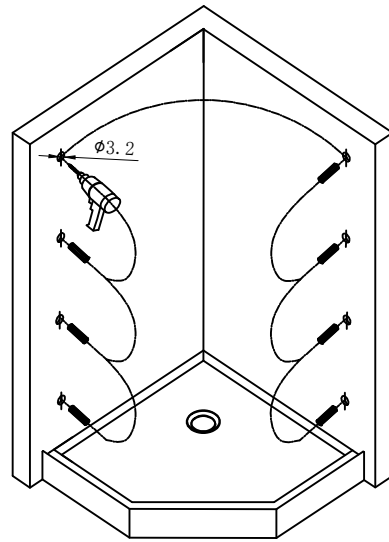

3

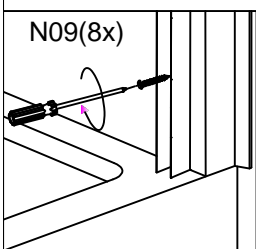
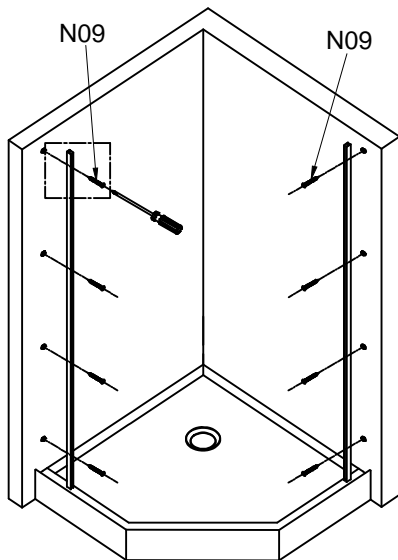

4

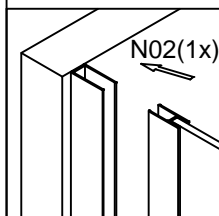
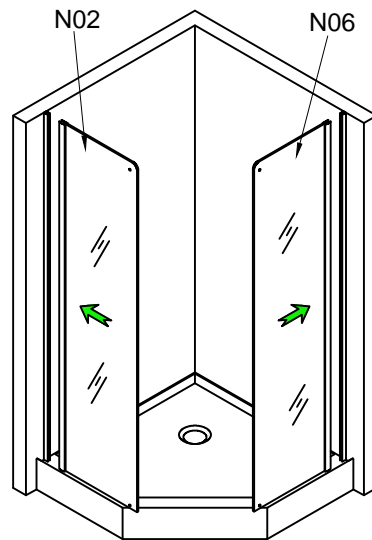

5

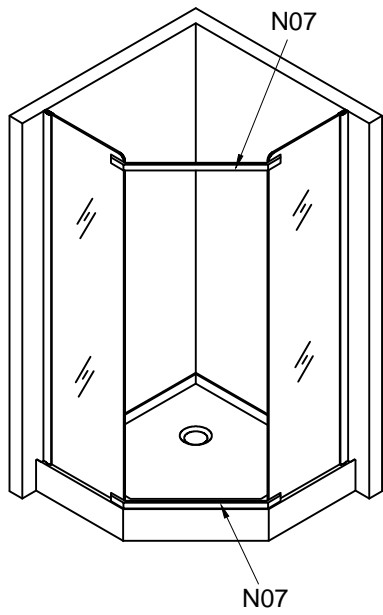

6

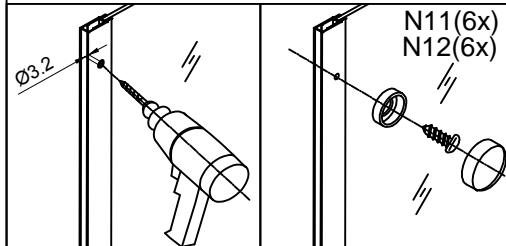
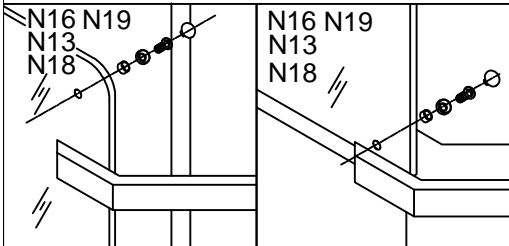
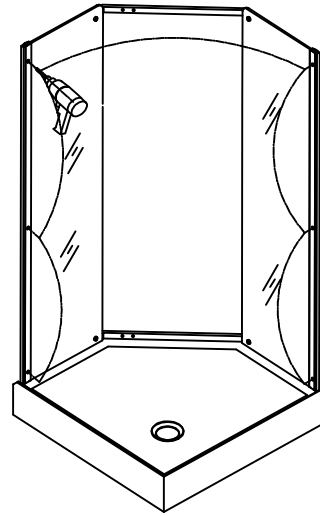

7

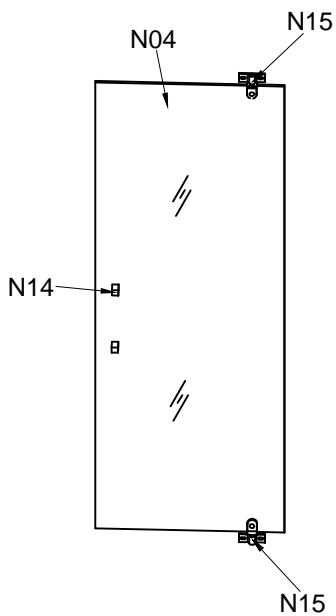

8

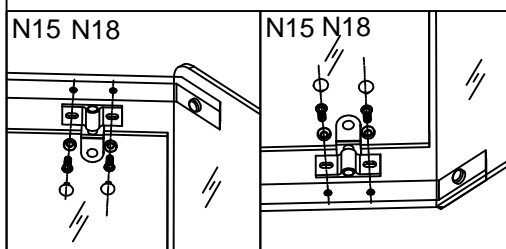
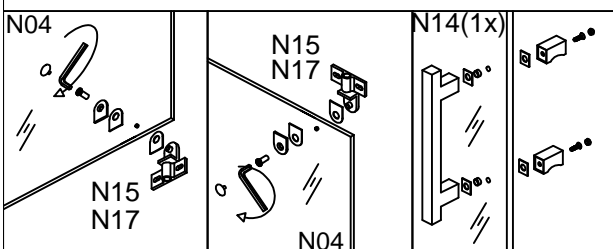
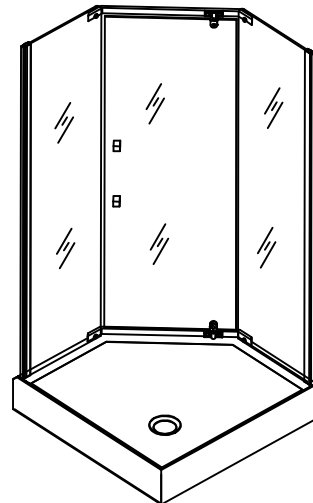

9

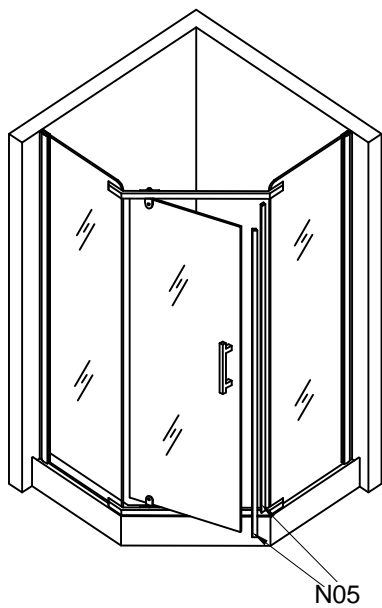

10

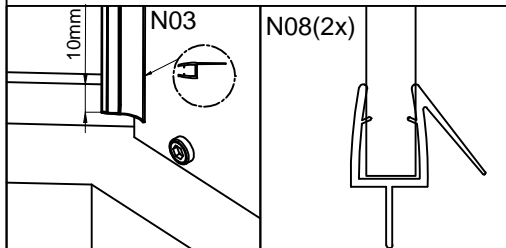
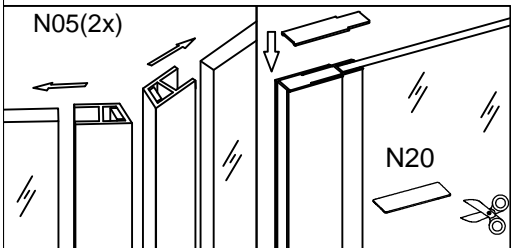
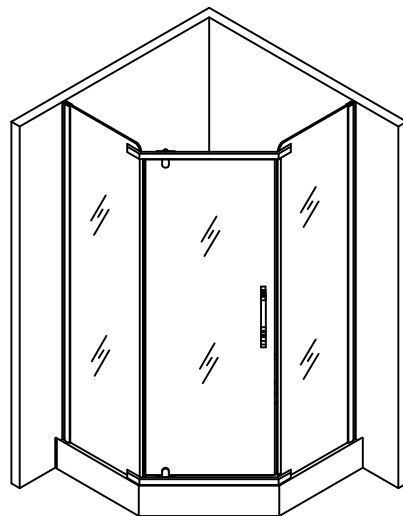

11

